

Part Number: PT278-08101

NOTE: Part number of this accessory may not be the same as the part number shown.

Kit Contents

Item #	Quantity Reqd.	Description
1	2	Cross Bar Assembly
2	1	Instructions
3		

Hardware Bag Contents

Item #	Quantity Reqd.	Description
1		
2		
3		
4		

Additional Items Required For Installation

Item #	Quantity Reqd.	Description
1		

Conflicts

--

Recommended Tools

Personal & Vehicle Protection	Notes
Protective Cloth	
Special Tools	Notes
Installation Tools	Notes
Special Chemicals	Notes
Cleaner	VDC approved cleaner

General Applicability

Vehicles with factory roof rack base rails.

Recommended Sequence of Application







Item #	Accessory

*Mandatory

Vehicle Service Parts (may be required for reassembly)

Item #	Quantity Reqd.	Description

Legend

	STOP: Damage to the vehicle may occur. Do not proceed until process has been complied with.
	OPERATOR SAFETY: Use caution to avoid risk of injury.
	CAUTION: A process that must be carefully observed in order to reduce the risk of damage to the accessory/vehicle and to ensure a quality installation.
	TOOLS & EQUIPMENT: Used in Figures calls out the specific tools and equipment recommended for this process.
	REVISION MARK: This mark highlights a change in installation with respect to previous issue.
	SAFETY TORQUE: This mark indicates that torque is related to safety.

Section II - Installation Procedure

Care must be taken when installing this accessory to ensure damage does not occur to the vehicle. The installation of this accessory should follow approved guidelines to ensure a quality installation.

These guidelines can be found in the "Accessory Installation Practices" document.

This document covers such items as:

- Vehicle Protection (use of covers and blankets, cleaning chemicals, etc.).
- Safety (eye protection, rechecking torque procedure, etc.).
- Vehicle Disassembly/Reassembly (panel removal, part storage, etc.).
- Electrical Component Disassembly/Reassembly (battery disconnection, connector removal, etc.).

Please see your Toyota dealer for a copy of this document.

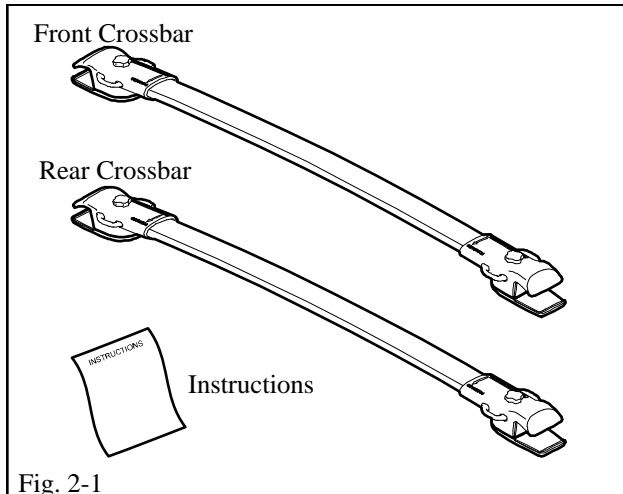

1. Vehicle Preparation.

-  (a) Clean work area before installing crossbars
- (1) Saturate a clean lint-free cloth with approved cleaner and clean the work surface of the vehicle. Follow the solvent manufacturer's directions carefully. Do not allow cleaner to air dry.
 - (2) Wipe the clean surface with a clean, dry, lint-free cloth.

2. Install Crossbars

- (a) Remove crossbars and instructions from packing. (Fig. 2-1)
- (b) Loosen clamps by turning knobs counterclockwise (Fig. 2-2)
-  (c) Rotate lower clamp 90°, so that the crossbars can be lowered between the roof rails (Fig.2-2)

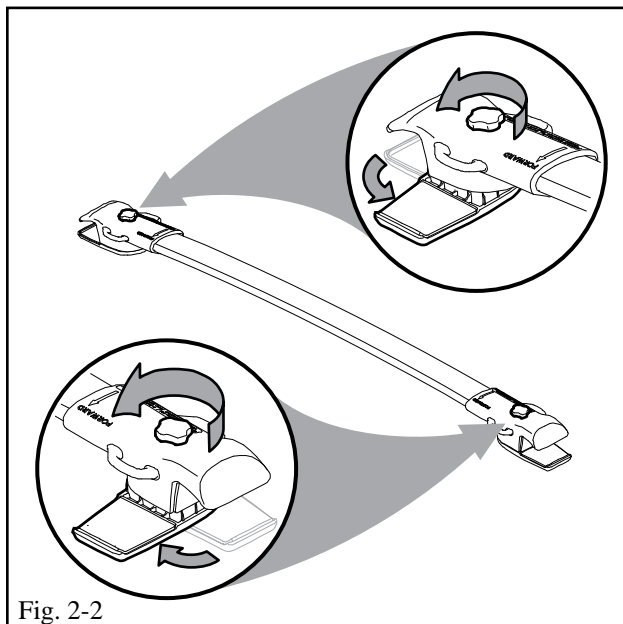

(d) Lower crossbars between roof rails. (Fig. 2-3).

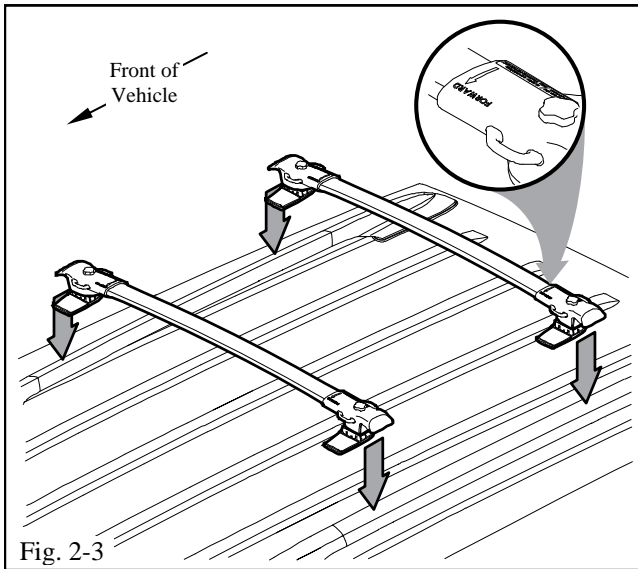

Note: Front and Rear Crossbars are interchangeable. FORWARD arrow on clamp facing towards the front of vehicle.

 (e) Position front and rear crossbars so that they are parallel A = 820mm (32-1/4 in), B = 120mm (4-3/4in) from the end of the rail. (Fig. 2-4)

 (f) Once in position, rotate lower clamps under side rails (Fig. 2-5a). Tighten clamps by turning knobs clockwise as much as possible until secure (Fig. 2-5b).

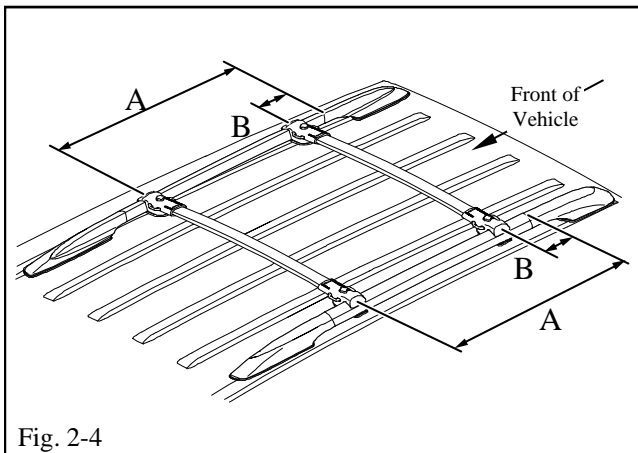

NOTE: Ensure there is no gap between the end support and side rail on the vertical surface both left and right side.

(g) Place installation instructions in glove box.

NOTE: To avoid injury or damage, periodically verify crossbars are secure and observe load limits as printed on crossbars.

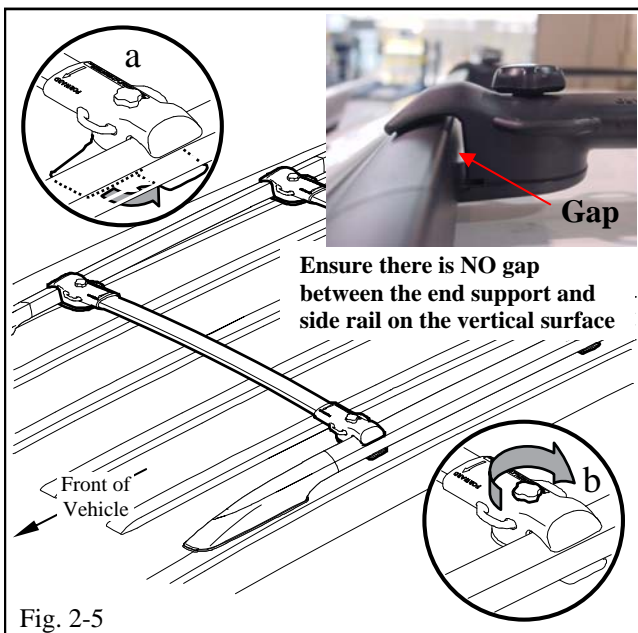

Checklist - these points **MUST** be checked to ensure a quality installation.

Check:

Look For:

Accessory Function Checks

- Crossbars are secure
- End support gap
- Installation Instructions

Securely tightened knobs

There is no gap between the end support and side rail on the vertical surface

Installation Instructions are in the glove box

Vehicle Function Checks

- None Required